



SEAL MASTER CORPORATION

368 MARTINEL DRIVE - KENT, OHIO 44240-4368 - USA

Phone 330-673-8410 - Fax 330-673-8242

www.sealmaster.com - info@sealmaster.com

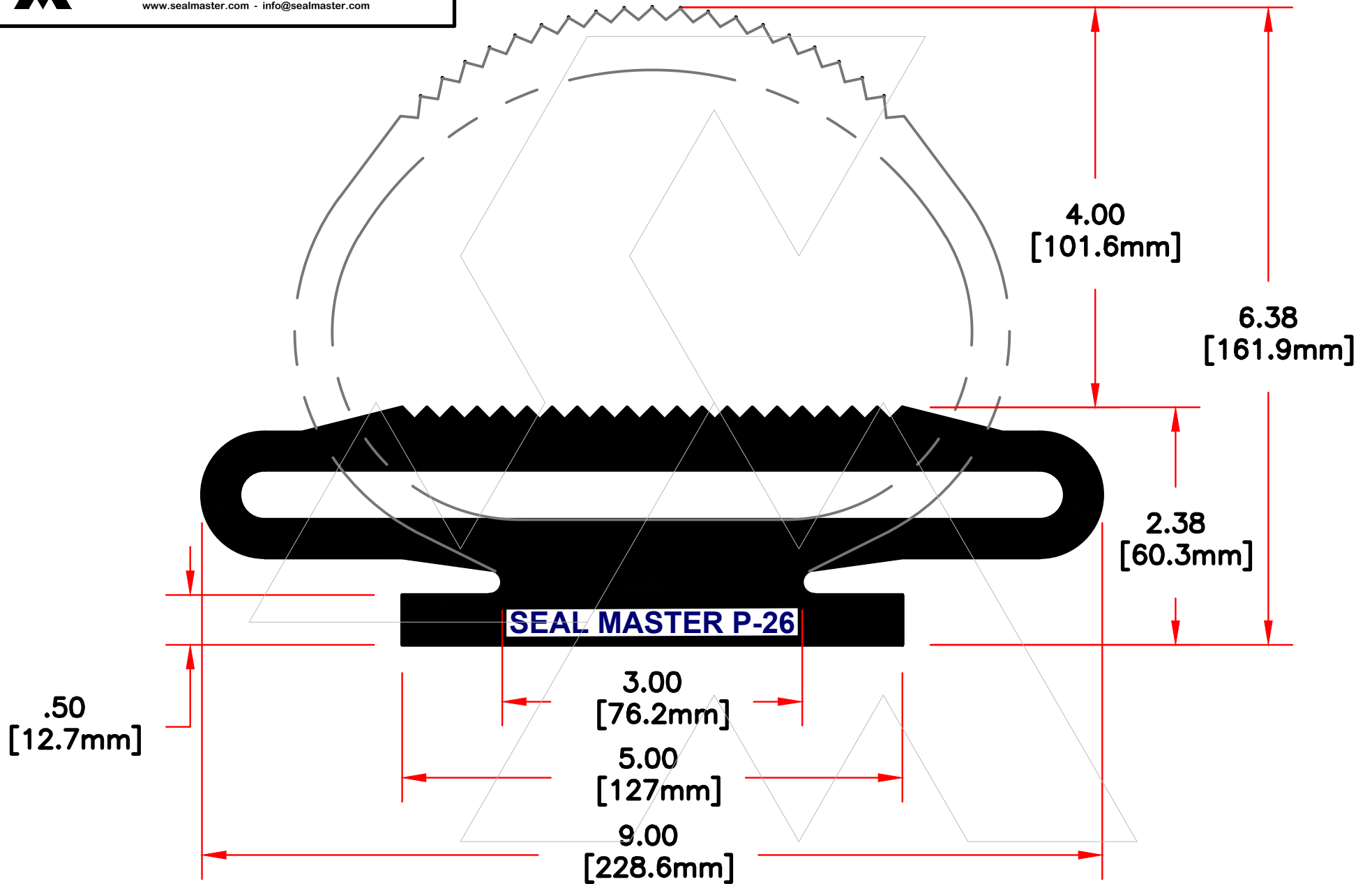

FASTEN TYPE P-26